

 ENGLISH

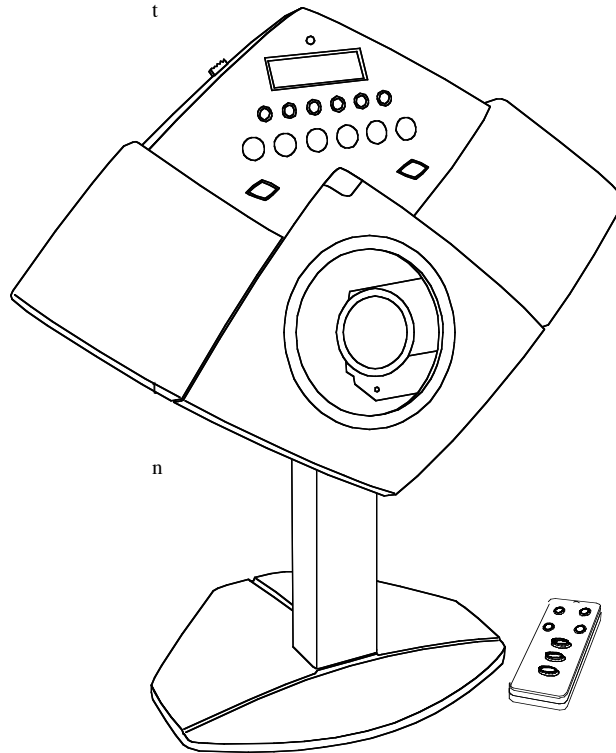

## Digital CD/Radio Stereo System with Remote

MODEL : RCD739UK





### **INSTRUCTION MANUAL** **Operating Instructions**



**BEFORE OPERATING THIS PRODUCT, READ, UNDERSTAND,  
AND FOLLOW THESE INSTRUCTIONS.**  
Be sure to save this booklet for future reference.

**SAFETY INSTRUCTIONS**

 <p>The Lightning flash with arrowhead symbol, with an equilateral triangle is intended to alert the user of the presence of uninsulated dangerous voltage within the product's enclosure that may be of sufficient magnitude to constitute a risk of electric shock to persons.</p>	<div style="border: 1px solid black; padding: 5px; text-align: center;"> <p><b>CAUTION</b></p> <p><b>RISK OF ELECTRIC SHOCK</b></p> <p><b>DO NOT OPEN</b></p> </div> <p>CAUTION: TO REDUCE THE RISK OF ELECTRIC SHOCK, DO NOT REMOVE COVER (OR BACK). NO USER SERVICEABLE PARTS INSIDE. REFER SERVICING TO QUALIFIED SERVICE PERSONNEL.</p>	 <p>The exclamation point within an equilateral triangle is intended to alert the user of the presence of important operating and maintenance (servicing) instructions in the literature accompanying the appliance.</p>
---	---	---

**CAUTION :** TO PREVENT ELECTRIC SHOCK, MATCH WIDE BLADE OF PLUG TO WIDE SLOT, FULLY INSERT.

**WARNING :** TO REDUCE THE RISK OF FIRE OR ELECTRIC SHOCK, DO NOT EXPOSE THE APPLIANCE TO RAIN OR MOISTURE.

**SAFETY INSTRUCTIONS**

THESE IMPORTANT SAFETY INSTRUCTIONS ARE INCLUDED, AS APPLICABLE TO THE APPLIANCE, CONVEYING TO THE USER THE INFORMATION ITEMIZED BELOW

1. Read instructions-All the safety and operating instructions should be read before the appliance is operated.
2. Retain instructions-The safety and operating instructions should be retained for future reference.
3. Head Warnings-All warnings and cautions on the appliance and in the operating instructions should be adhered to.
4. Follow instructions-All operating and use instructions should be followed.
5. Water and Moisture-The appliance should not be used near water, e.g. near a bathtub, washbowl, kitchen sink, laundry tub, in a wet basement, or near a swimming pool or the like.
6. Wall or Ceiling Mounting-The appliance should not be mounted to a wall or ceiling.
7. Ventilation-The appliance should be situated so that its location or position does not interfere with its proper ventilation. For example, the appliance should not be situated on a bed, sofa, rug or similar surface that may block the ventilation openings, or placed in a built-in installation, such as a bookcase or cabinet, that may impede the flow of air through the ventilation openings.
8. heat-The appliance should be situated away from neat sources such as radiators, heat registers, stoves, or other appliances (including amplifiers) that produce heat..
9. Power Sources-The product should be operated only with the type of power supply indicated on the marking label. If you are not sure of the type of power supply to your home, consult your product dealer or local power company. For products intended to operate from battery power, or other sources, refer to the operation instructions.
10. Grounding Polarization-This product may be equipped with a polarized alternating current line plug (a plug having one blade wider than the other). This plug will fit into the power outlet only one way this is a safety feature. If you are unable to insert the plug fully into the outlet, try reversing the plug. If the plug should still fail to fit, contact your electrician to replace your obsolete outlet. Do not defeat the safety purpose of the polarized plug.
11. Power-Cord Protection-Power supply cords should be routed so that they are not likely to be walked on or pinched by items placed upon or against them, paying particular attention to cords at plugs, convenience receptacles, and the point where they exit from the appliance.

12. Cleaning-The appliance should be cleaned only as recommended by the manufacturer.
13. Nonuse periods-The power cord of the appliance should be unplugged from the outlet when left when left unused for a long period of time.
14. Object and Liquid Entry-Care should be taken so that objects do not fall and liquids are not spilled into the product case through product openings.
15. Damage Requiring Service-Unplug this product from the wall outlet and take it to qualified service personnel under the following conditions.
  - a) When the power-supply cord or plug is damaged.
  - b) If liquid has been spilled into, or objects have fallen into the product.
  - c) If the product has been exposed to rain or water.
  - d) If the product does not operate when used according to the operating instructions. Adjust only those controls that are covered by the operating instructions as an improper adjustment of other controls may interfere with the product's normal operation.
  - e) If the product has been dropped or damaged in any way.
  - f) When the product exhibits a distinct change in performance-this indicates a need for service.
16. Servicing-The user should not attempt to service the product beyond that described in the operating instruction. All servicing should be referred to qualified service personnel.
17. Power Lines-An outside antenna system should not be located in the vicinity of overhead power lines, or other electric light or power circuits, or where it can fall into such power lines or circuits. When installing an outside antenna system, extreme care should be taken to keep from touching power lines or circuits as contact with them might be fatal.
18. If an outside antenna is connected to the receiver, be sure the antenna system is grounded so as to provide some protection against voltage surges and built up static.
  
19. Cleaning-Unplug this product from the wall outlet before cleaning. Do not use liquid cleaners or aerosol cleaners. Use a damp cloth for cleaning.
20. Lightning-For added protection for this product during a lightning storm, or when it is left unattended and unused for long periods of time, unplug it from the wall outlet and disconnect the antenna or cable system. This will prevent damage to the product due to lightning and power-line surges.
21. Safety Check-Upon completion of any service or repairs to this product, ask the service technician to perform safety checks to determine that the product is in proper operation condition.
22. Overloading-Do not overload wall outlets, extension cords, or integral convenience receptacles as this can result in a risk of fire or electric shock.

az

### **CAUTION**

**Invisible laser radiation will be emitted when the product is open and interlocks are defeated. Do not defeat the safety interlocks.**

**GRAPHIC SYMBOLS WITH SUPPLEMENTARY MARKINGS ARE LOCATED ON THE BOTTOM OF THE UNIT.**

**USE OF CONTROLS, ADJUSTMENTS, OR PERFORMANCE PROCEDURE HEREIN MAY RESULT IN HAZARDOUS RADIATION EXPOSURE.**

**MOUNTING LOCATION**

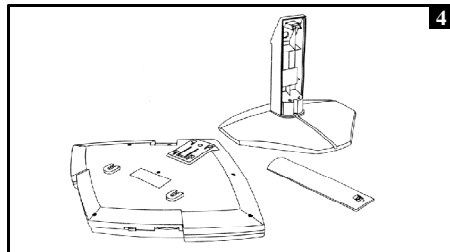
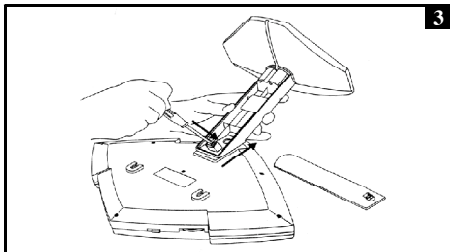
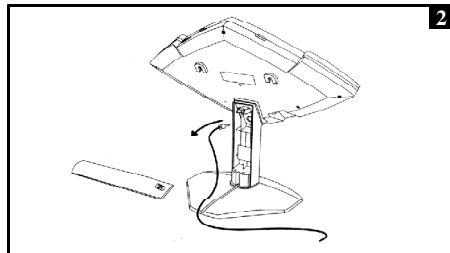
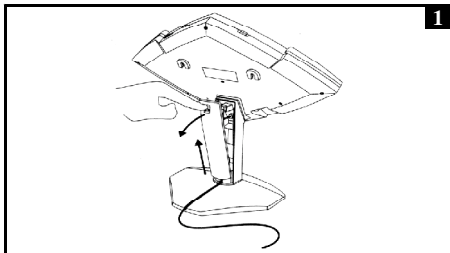
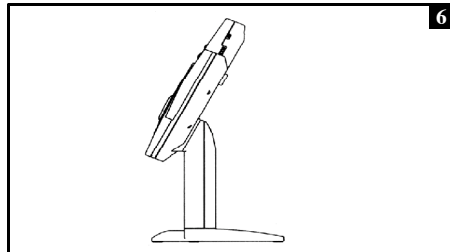
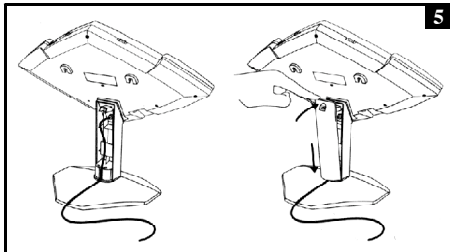
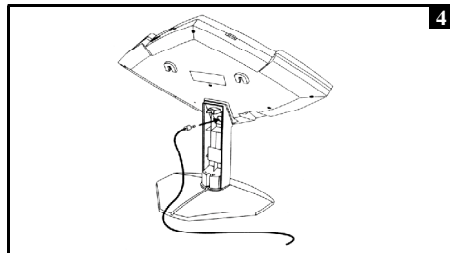
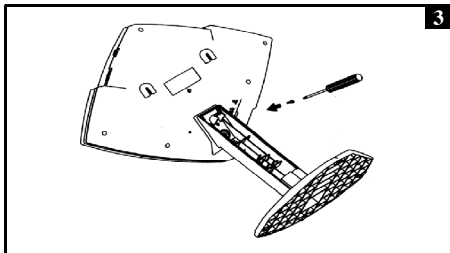
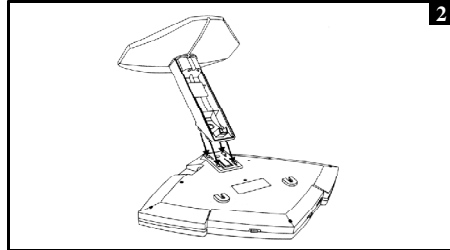
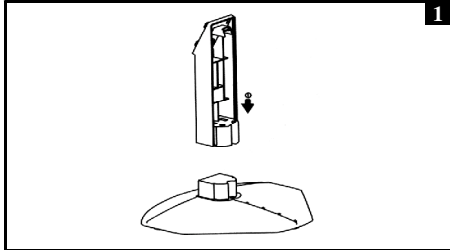

**LOCATION OF CONTROLS**

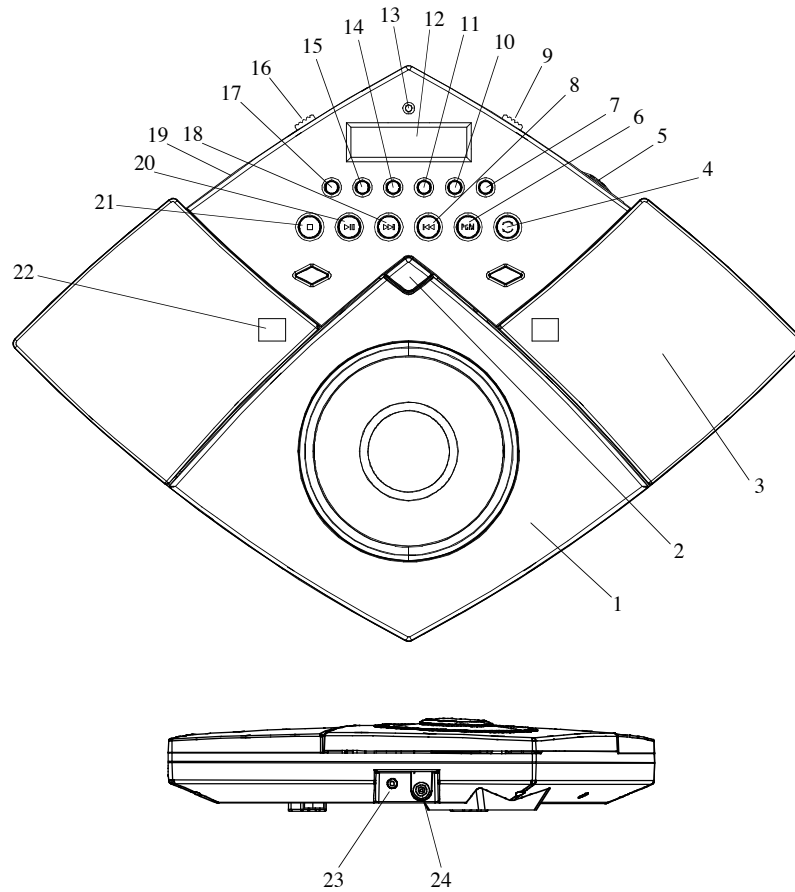

- |   |                                   |
|---|-----------------------------------|
| 1. CD Door                                | 13. Stereo LED Indicator          |
| 2. CD Door Open Button                    | 14. Hour Set Button               |
| 3. Speaker                                | 15. Alarm Set Button              |
| 4. Repeat Button                          | 16. Selector Switch (ON/OFF/AUTO) |
| 5. Volume Control Knob                    | 17. Time Set Button               |
| 6. Program Button                         | 18. SKIP (REWIND) button          |
| 7. Random Button                          | 19. Tuning Control Knob           |
| 8. SKIP (FAST-FORWARD) button             | 20. CD Play/Pause Button          |
| 9. Function Switch (CD, AM, FM )          | 21. CD Stop Button                |
| 10. Alarm ON/OFF Button                   | 22. Remote Sensor                 |
| 11. Minute Set Button                     | 23. Headphone Jack                |
| 12. LCD Display (CD, Clock and Frequency) | 24. DC Input Jack                 |

### **REMOTE CONTROL**

1. PLAY Button
2. SKIP (FAST-FORWARD) button
3. Program Button
4. Repeat Button
5. Random Button
6. STOP Button
7. SKIP (REWIND) button

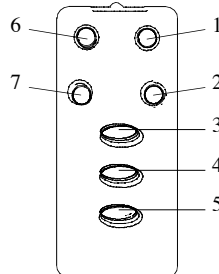

### **AC OPERATION**

To operate the unit using AC power , connect a 9V AC adaptor (included) to an AC outlet having 230V AC.

**CAUTION:** When not using AC power, disconnect the AC adapter from the wall outlet by pulling the plug (not the cord). Do not touch the AC adapter with wet hands and plug fully inserted without exposing any part of the blade.

### **HEADPHONE JACK**

This unit will accept stereo headphones with a Ø 3.5mm plug. Before connecting the headphones set the volume to minimum level as not to damage your ears or the headphones. Connect the headphones to the headphones jack. The speakers will be automatically disconnected.

**Warning:** Prolonged exposure to high sound levels may permanently damage your hearing. You may not hear some warning sound while wearing these headphones.

### **VOLUME CONTROL**

Adjust the VOLUME control to the desired level.

### **RADIO SECTION**

#### **LISTENING TO THE RADIO**

1. Slide SELECTOR Switch to "ON" position.
2. Slide FUNCTION Switch to select AM or FM position
3. Rotate the Tuning Control Knob to your desired Radio station.
4. To turn off Radio, Slide SELECTOR switch to "OFF" position to turn off the unit.

For better reception,

This unit has a built-in antenna for AM/FM, Locate the unit where you can obtain the best reception.

### **CLOCK SECTION**

#### **CLOCK SETTING**

Press and hold Time./SET button to set the clock  
Press Hour or Min button respectively

**Note:** In radio mode, the frequency will appear at the location where time appears. Press and hold the Time/Set button to display the current time; Press and hold the AL./Set button to display the current alarm time.

#### **ALARM TIME SETTING**

1. Slide SELECTOR switch to "OFF" or "AUTO" position.
2. Press and hold AL. SET button to set the Alarm time
3. Press Hour or Min button respectively.
4. Turn on the alarm function by pressing AL.ON/OFF button till the alarm Icon appears

**Note.** While alarm time is on, it will alarm for 3 minutes. To turn off the alarm, press the AL.ON/OFF button once.

#### **Wake up by Buzzer**

1. After set the desired alarm time. And press the AL.ON /OFF button till the alarm icon appears
2. Slide the SELECTOR switch to "OFF" position.

#### **Wake up by CD or Radio**

1. Slide SELECTOR switch to "AUTO" position.
2. Set your desired alarm time.
3. Turn on the alarm function by pressing AL.ON/OFF button till the alarm Icon appears
4. Slide the SELECTOR switch to "AUTO" position.
5. Slide the Function Switch to CD, AM or FM position.

When the alarm time is on, CD & RADIO(AM/FM) will be automatically played.

### **CD SECTION**

#### **PLAYING A CD**

1. Press the Open button of CD Door where remarked "Open" to open the CD Door.
2. Insert a CD with the label facing upward.
3. Close the CD compartment by pressing the upper corner of CD Door.
4. Slide the FUNCTION switch to CD position
5. Slide the SELECTOR switch to "ON" position to turn on the unit.  
The CD will rotate for a while and then stop.
6. Press PLAY/PAUSE button to start CD playback from the first track.
7. Press once more PLAY/PAUSE button to momentarily pause, Icon "▶" will flash. Press again PLAY/PAUSE button to resume to playback
8. To stop the playback, Press STOP button.

#### **TRACK SEARCH**

Press the SKIP/SEARCH button during play to skip to the desired track.

Press the "F.FWD" button to skip to the next track on the disc.

Press the "REW" button to skip to the beginning of the current track

Press the "REW" button twice or more to skip to previous track.

#### **FORWARD/REVERSE SEARCH**

Press and hold the Forward or Backward SKIP/SEARCH button during play to scan the disc at high speed.

When the desired section of the disc is found, release the Button and normal play will resume.

"F.FWD" -----Forward

"REW" -----Backward

Press and hold the "F.FWD" button while playing to scan the current track forward at high speed.

Press and hold the "REW" button while playing to scan the current track backward at high speed.

**PROGRAMMED PLAYBACK**

Up to 20 tracks can be programmed in to play in any desired sequence.

1. Press the Open button of CD Door where remarked "Open" to open the CD Door.
2. Insert a CD with the label side facing upward.
3. Close the CD compartment by pressing the upper corner of CD Door.
4. Slide the FUNCTION Switch to CD position
5. Slide the SELECTOR Switch to ON position to turn on the unit.  
The CD will rotate for a while and then stop.
6. Press PROG button until "PROG 01" flashes in display.
7. Press SKIP Forward or SKIP Backward button to select a desired track to be memorized.
8. Press PROG button to program the track.
9. Repeat steps 7 and 8 to program tracks.
10. Press PLAY/PAUSE button to start playing.

To cancel program play, Press STOP button two times.

**REPEAT PLAY**

To Repeat Single Track

Press REPEAT button on the remote control while the track you want to repeat is playing. The "REPEAT" flashing will appear in display.

- Press REPEAT two times on the remote control.
- Press REPEAT button on the remote control twice during play.
- To repeat another track, Press REW or FWD SKIP button.
- To cancel repeat play, Press REPEAT button two times.

**To Repeat all the tracks**

Press REPEAT button twice during play. The "REPEAT" indicator will appear in display.

- All tracks will be played through in sequence and then the sequence will be repeated continuously.
- To cancel repeat play, press REPEAT button one time.

**Random play**

Press stop button to enter into stop mode, press Random button once then press play/pause button to carry out random play, "RANDOM" will appear in display.

All tracks on the disc will be played in random order, then will stop.

During random playing, To cancel random play, press stop button twice.

**HANDLING DISCS**

This product is designed to play CDs bearing the DISC Identification logo.



CD not carrying this logo may not conform to the CD standard and may not play properly.

Dirty, scratched, or warped discs may cause skipping or noise.

- Handle the CD only by the edges.
- To keep the CD clean, do not touch the surface of the disc.
- Return CDs to their original cases after use to avoid serious scratches that could cause the laser pickup to skip.
- Do not expose CDs to direct sunlight, high humidity or high temperatures for extended periods of time, as prolonged exposure to high temperatures can warp CDs
- Do not apply paper or write anything on either side of a CD. Sharp writing instruments or the inks in some felt-tip pens, may damage the surface of a CD

**TO Clean CDs:**

- Fingerprints should be wiped from the surface of the CD with a soft cloth. Unlike conventional records, CDs have no grooves to collect dust and microscopic debris, so gently wiping the CDs with a cloth removes most of the particles.
- Wipe in a straight motion from the inside to the outside of the CD.
- Never use chemicals (i.e. record cleaning sprays, anti-static sprays, benzene or thinner) to clean CDs, as damage to the plastic of the CD may result.





**To clean the CD player:**

Dust on the pickup lens can lead to erratic operation and interruption of the sound during play.

NOTE: Do not touch the surface of the pickup lens. Do not allow any liquids on the inside of the product.

-----To clean the pickup lens, open the CD Door and blow the dust off of the pickup lens using a camera lens blower(available at most camera stores)

-----To clean the CD player cabinet , use a soft , damp cloth to wipe off the exterior surface.

-----Never use benzene or other strong chemical cleaners ,as these could damage the product's finish.

**TROUBLESHOOTING GUIDE**

You experience a problem with this unit check the chart below before calling of service.

SYMPTOM	CAUSE	SOLUTION
CD Player will Not turn on	<ul style="list-style-type: none"> <li>• Wrong adapter being used</li> <li>• AC adapter not connected properly</li> </ul>	
Disc will notPlay	<ul style="list-style-type: none"> <li>• Disc inserted incorrectly</li> <li>• Defective compact disc</li> <li>• CD compartment not closed</li> <li>• Moisture condensationon disc</li> </ul>	<ul style="list-style-type: none"> <li>• Reinsert disc with label side facing up</li> <li>• Try another compact disc</li> <li>• Close CD compartment</li> <li>• Wipe disc with soft cloth</li> </ul>
Erratic CDplayback	<ul style="list-style-type: none"> <li>• Dirty or defective disc</li> </ul>	<ul style="list-style-type: none"> <li>• Clean or replace disc</li> </ul>
No sound	<ul style="list-style-type: none"> <li>• Headphone plug not inserted properly</li> <li>• Volume control set to minimum</li> <li>• Defective compact disc</li> <li>• FUNCTION is not set to the desired position</li> </ul>	<ul style="list-style-type: none"> <li>• Reinsert headphone cord into headphone jack</li> <li>• Increase the volume</li> <li>• Try another compact disc</li> <li>• press FUNCTION SELECTOR switch to the desired function</li> </ul>
Noise or Sound distorted on radio	<ul style="list-style-type: none"> <li>• Station not tuned properly for FM</li> </ul>	<ul style="list-style-type: none"> <li>• Retune FM broadcast station</li> </ul>

**CARE AND MAINTENANCE**

**CARING FOR COMPACT DISCS**

--- To keep the CD clean, handle it by its edge. Do not touch the surface.

--- Do not stick paper or tape onto the CD

--- Do not expose the CD to direct sunlight or heat sources such as holt air ducts.

Do not leave the CD in a car parked under direct sunlight.

**Cleaning the Unit**

--- To prevent fire or shock hazard , disconnect your unit from the AC power source when cleaning.

--- The finish on your unit may be cleaned with a dust cloth and cared for as other furniture.

Use caution when cleaning and wiping the plastic parts.

---Mild soap and a damp cloth may be used on the front panel.

**IMPORTANCE**

To keep up the clock's operating, Remember to turn off the unit by sliding the SELECTOR switch A to AL.OFF position as the clock memory will be lost if you disconnect your unit from the AC power source.